

SV-2 X SUB D 25ST-KL FOR SIGNAL TRANSFER

125 VAC/DC / 2 A

Male connector
25-pole
Screw terminals

Illustration

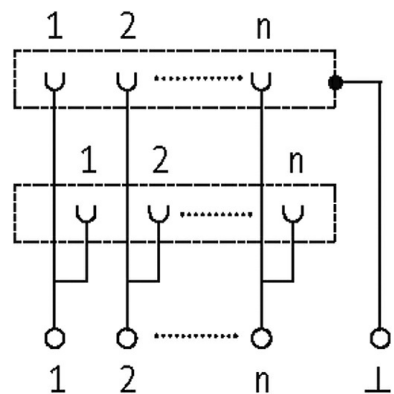
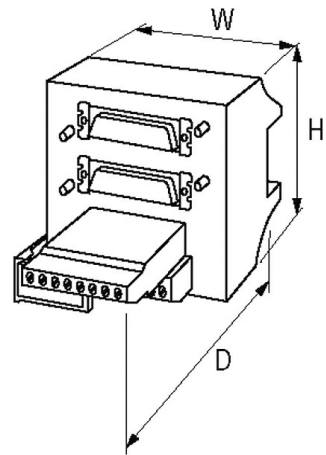

Picture: female

Product may differ from Image

General data

Mounting method	DIN-rail mountable (EN 60715)
Temperature range	-20...+70 °C
Dimensions H×W×D	75×90×66 mm

Technical Data

Operating voltage	125 V AC/150 V DC
Operating current per bit	max. 2 A
Material group	EN 60664-1 over voltage, category I
Locking of ports	Standard UNC 4-40 screw thread bolt (EN 60807)

Commercial data

country of origin	CZ
customs tariff number	85366990
EAN	4048879026161
eClass	27143424
Packaging unit	1